

Refresh Home Lock Info

Manufacturing Pharmacy
Garden Unit AHU AC92

Maintenance Alarms: 0
Fault Alarms: 0
Critical Alarms: 0

30-Apr-26 2:25 PM BST
User: admin
0.0 °C 0 %RH

- Daily Checks
- AHUs
- Buildings
- Chilled Water Systems
- Cold Water Services
- Dashboards
- Departments
- Duct Temps
- Domestic Hot Water Services
- Electrical
- Floors
- Gases
- Generators
- Heating Systems
- Metering
- Manufacturing
- Outside Air Control
- Plantrooms
- Ventilation
- Historics

Menu

Time Schedule

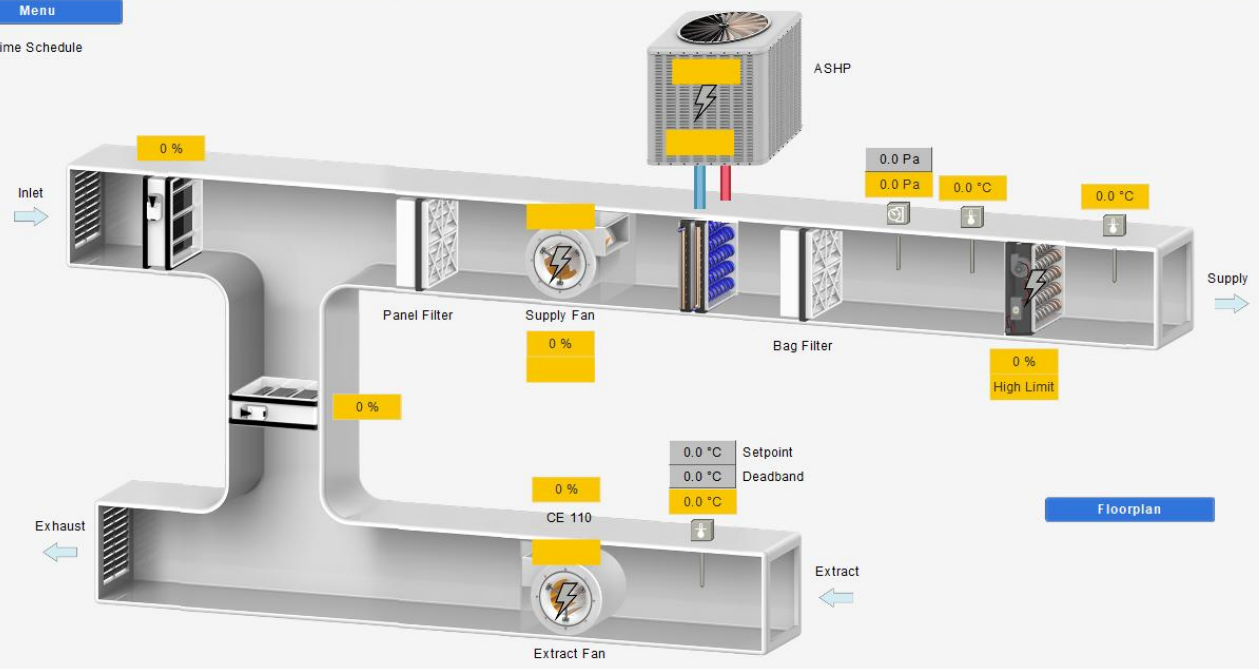

Floorplan

Plant Conditions		Adjustments		Adjustments	
Activated	Fire Alarm	Auto	SF Speed Manual O/r	0.0 °C	Electric Htr Normal Sp
Healthy	Common Fault	0 %	SF Speed Man. Sp	0.0 °C	Electric Htr Defrost Sp
Reset	Fault Display Lamp	0 %	EF Speed Setpoint		
Off	All Fans Manual Off	0 %	Dampers Position		

Manufacturing Pharmacy Sterile Fluids AHU 00AC93B

Maintenance Alarms: 0
Fault Alarms: 0
Critical Alarms: 0

30-Apr-26 2:25 PM BST
User: admin
0.0 °C 0 %RH

- Daily Checks
- AHUs
- Buildings
- Chilled Water Systems
- Cold Water Services
- Dashboards
- Departments
- Duct Temps
- Domestic Hot Water Services
- Electrical
- Floors
- Gases
- Generators
- Heating Systems
- Metering
- Monitoring
- Outside Air Control
- Plantrooms
- Ventilation
- Histories

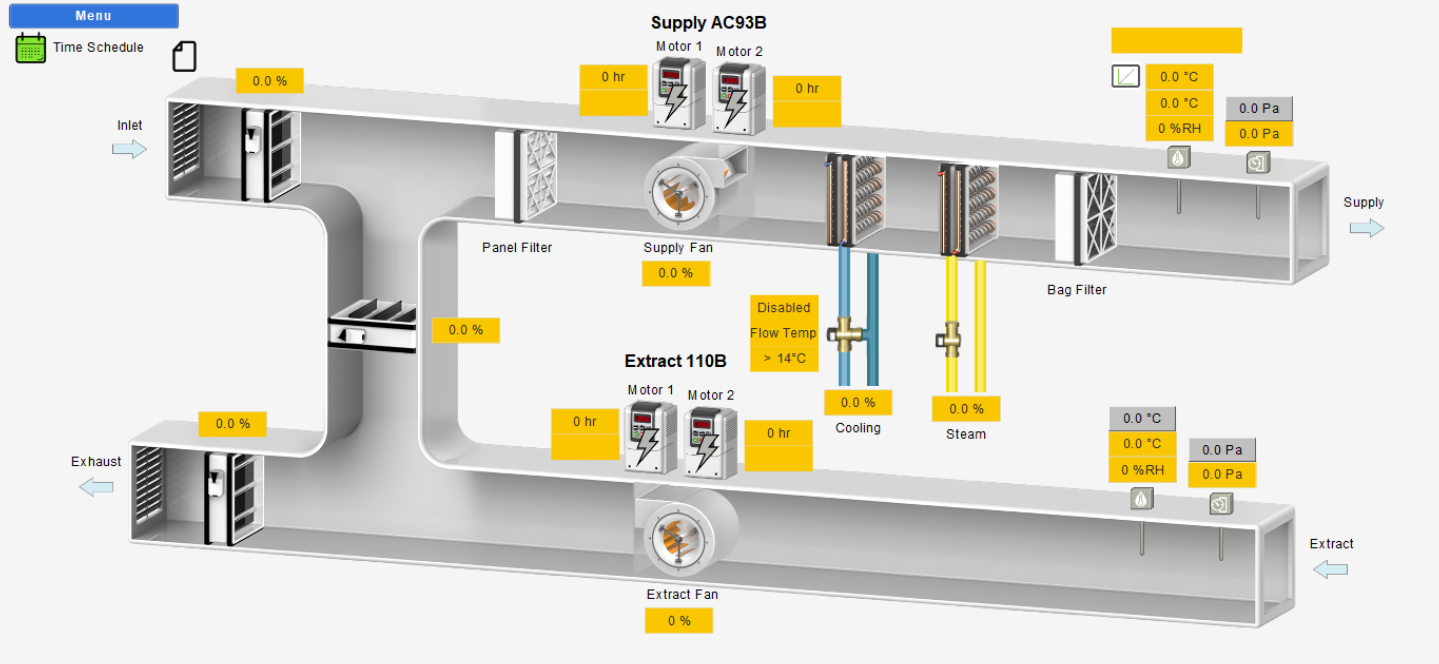

Plant Conditions		Chiller		Supply Fan Adjustments		Extract Fan Adjustments		Adjustments		Adjustments	
Activated	Fire Alarm	0.0 °C	ChW Flow Temp	Motor 1	Fan Duty	Motor 1	Fan Duty	0.0 °C	Low Tmp Shutdown Sp	0.0 Pa	Filter Alarm Delay
Off	Plant Demand	0.0 °C	ChW Return Temp	Off	Inhibit Duty Change	Off	Inhibit Duty Change	0.0 min	Temp Shutdown Delay	Reset	Filter Alarm Reset
Healthy	Common HEPA Filter	Healthy	Chiller Fault	Reset	Flow Fail Reset	Reset	Flow Fail Reset	Reset	Temp Shutdown Reset	0 %	Fresh Air Inlet Setpoint
0.0 °C	Calc. Heating Setpoint	Disable	Chiller Condition	Reset	Motor 1 Hours Reset	Reset	Motor 1 Hours Reset	0.0 min	Pre-Start Warmup Time		
0.0 °C	Calc. Cooling Setpoint	Healthy	ChW Temp Alarm	Reset	Motor 2 Hours Reset	Reset	Motor 2 Hours Reset	0 %RH	PreStart Htg Coil Output		



Floor G - Imaging & MRI
AHU 147 - MRI 1

Maintenance Alarms: 0
Fault Alarms: 0
Critical Alarms: 0

30-Apr-26 2:26 PM BST
User: admin
0.0 °C 0 %RH

- Daily Checks
- AHUs
- Buildings
- Chilled Water Systems
- Cold Water Services
- Dashboards
- Departments
- Duct Temps
- Domestic Hot Water Services
- Electrical
- Floors
- Gas
- Generators
- Heating Systems
- Metering
- Monitoring
- Outside Air Control
- Plantrooms
- Ventilation
- Historians

Imaging & MRI Menu

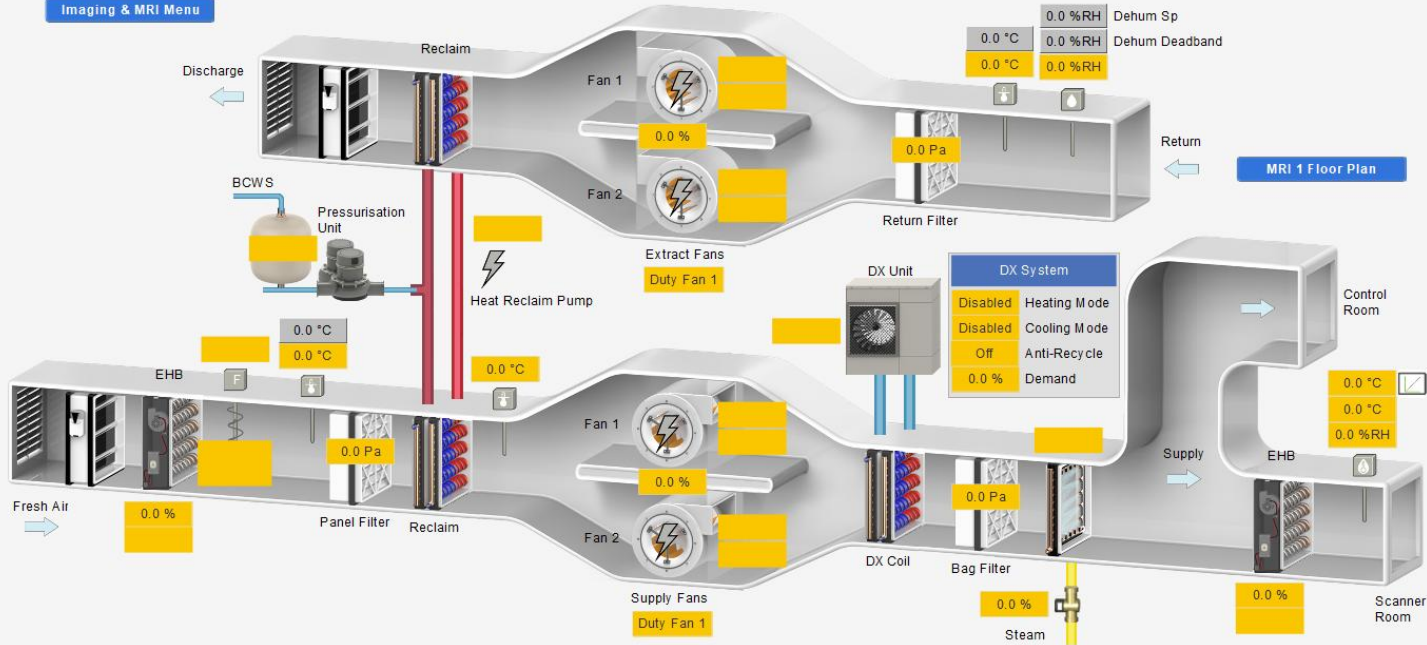

Safety Interlocks	
Activated	Fire Alarm
0.0 °C	Frost Shutdown Sp
Reset	Frost Reset

AHU Plant Conditions	
Off	Control
No	Allow Reheat Boost
Enable	Humidity Control
Off	Dehum Mode
0.0 %RH	Supply %Rh High Limit

Supply Fan Adjustments	
Duty Change Time	
Fan 1	Fan Duty
Off	Inhibit Duty Change
Reset	Fail Reset
0.0 %	Nominal Speed Sp

Extract Fan Adjustments	
Duty Change Time	
Fan 1	Fan Duty
Off	Inhibit Duty Change
Reset	Fail Reset
0.0 %	Nominal Speed Sp

Fan Run-On Adjustments	
No	Allow Run-On for Clg
0.0 min	Run-On Time
Off	Heating Mode Run-On
Off	Cooling Mode Run-On

Heat Reclaim Adjustments	
Off	Pump Control
No	Heating Available
0.0 %	Heating Demand
No	Cooling Available
0.0 %	Cooling Demand

Floor 1 - Imaging & MRI
AHU 1.01 - MRI 3

Maintenance Alarms: 0
Fault Alarms: 0
Critical Alarms: 0

30-Apr-26 2:26 PM BST
User: admin
0.0 °C 0 %RH

- Daily Checks
- AHUs
- Buildings
- Chilled Water Systems
- Cold Water Services
- Dashboards
- Departments
- Duct Temps
- Domestic Hot Water Services
- Electrical
- Floors
- Gas
- Generators
- Heating Systems
- Metering
- Monitoring
- Outside Air Control
- Plantrooms
- Ventilation
- Historics

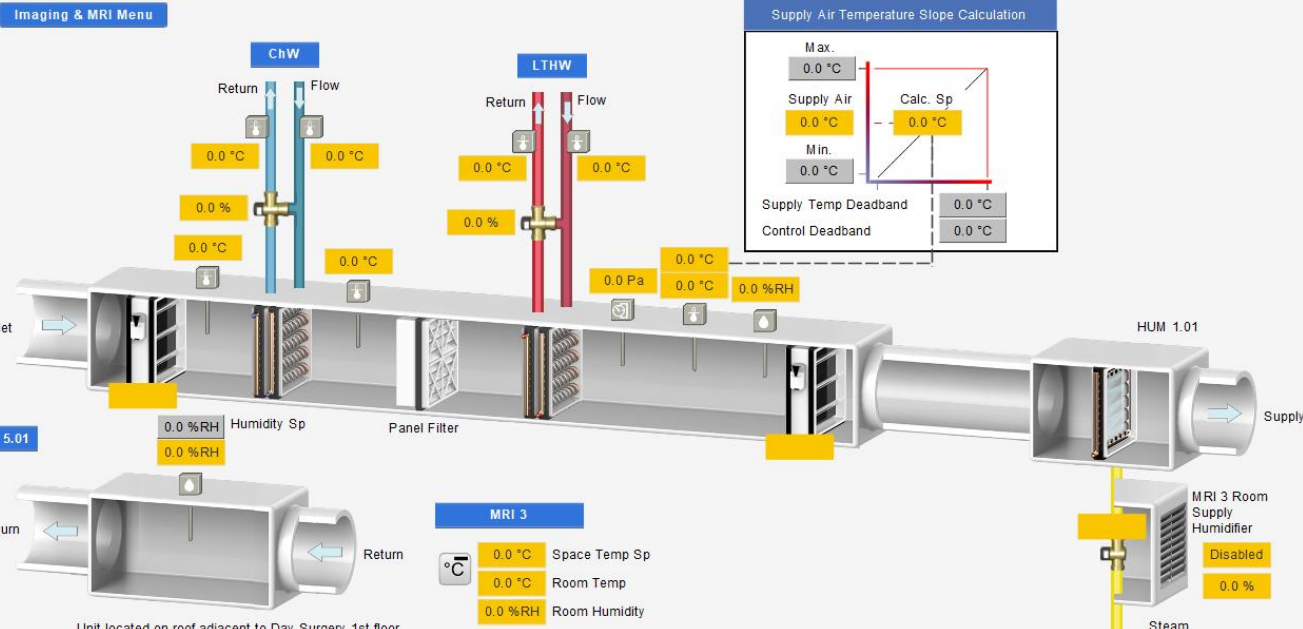

Safety Interlocks (AHU 5.01)	
Activated	Fire Alarm
Not In Auto	FireSw Supply Auto
Normal	FireSw Supply Hand
Not In Auto	FireSw Extract Auto
Normal	FireSw Extract Hand

Plant Conditions	
Off	Control
Reset	Supply Fail Reset

Supply	
Off	Humidity Control
0.0 %	Hum Demand
Disabled	Humidifier
0.0 %	Dehum Demand
0.0 %RH	High Humidity Sp
0.0 %RH	Low Humidity Sp

ChW System	
Off	Run Status
Healthy	Press. Unit Fault
Healthy	Chiller 1
Healthy	Chiller 2
Healthy	Chiller 3

LTHW PHX	
Off	PHX 1 Status
Healthy	PHX 1 Fault
Off	PHX 2 Status
Healthy	PHX 2 Fault
Healthy	Press. Unit Fault

Floor 4 H-West - Imaging & MRI
AHU 5.01 - MRI 3, CT 1 - 3

Maintenance Alarms: 0
Fault Alarms: 0
Critical Alarms: 0

30-Apr-26 2:26 PM BST
User: admin
0.0 °C 0 %RH

- Daily Checks
- AHUs
- Buildings
- Chilled Water Systems
- Cold Water Services
- Dashboards
- Departments
- Duct Temps
- Domestic Hot Water Services
- Electrical
- Floors
- Gases
- Generators
- Heating Systems
- Metering
- Monitoring
- Outside Air Control
- Plantrooms
- Ventilation
- Histories

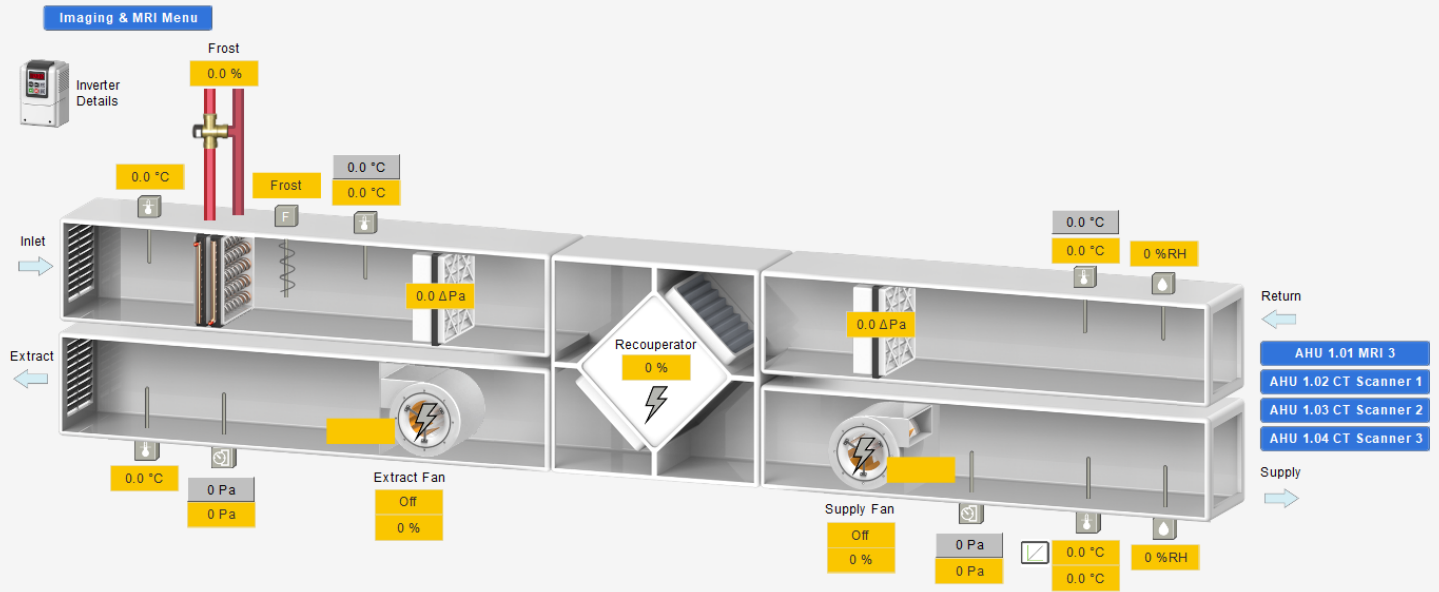

Safety Interlocks		AHU Plant Conditions		Supply Fan		Extract Fan		Heat Reclaim Adjustments	
Activated	Fire Alarm	Off	Control	0 %	Min. Speed	0 %	Min. Speed	Off	Control
Not In Auto	FireSw Supply Auto			0 %	Max. Speed	0 %	Max. Speed	No	Heating Available
Normal	FireSw Supply Hand	Filter Dirty Alarm Setpoints		Reset	Fail Reset	Reset	Fail Reset	0 %	Heating Demand
Not In Auto	FireSw Extract Auto	0.0 ΔPa	Supply Filter					No	Cooling Available
Normal	FireSw Extract Hand	0.0 ΔPa	Return Filter						

Refresh Home Lock Info

Service Floor - CBU
AHU TGU

Maintenance Alarms: 0
Fault Alarms: 0
Critical Alarms: 0

30-Apr-26 2:26 PM BST
User: admin
0.0 °C 0 %RH

Menu
TGU Floor Plan



Fabric Protection	
0.0 °C	OAT Frost Sp
Inactive	OAT Frost Active

Chilled Water System	
No Flow	Chilled Water Pumps
Healthy	Pressurization Unit
Disable	Chiller Enable
Healthy	Chiller Fault

Heating PHX	
No Flow	Heating Pumps
Healthy	Pressurization Unit
Disable	PHX Enable

Supply Fan Adjustments	
Fan 2	Fan Duty
Reset	Fail Reset
0.0	Weekly Changeover

Adjustments	
0.0 °C	Frost Shutdown Sp
0.0 °C	Preheat Valve Hold Off
0.0 Pa	Manual Pressure Level
Off	Manual Pressure Overd
0 %RH	Humidity High Limit Sp

Adjustments	
0.0 °C	AHU Max Supply Sp
0.0 °C	AHU Min Supply Sp

Refresh Home Lock Info

Service Floor - CBU
AHU 29-2

Maintenance Alarms: 0
Fault Alarms: 0
Critical Alarms: 0

30-Apr-26 2:26 PM BST
User: admin
0.0 °C 0 %RH

User Adjustments

CBU - Menu

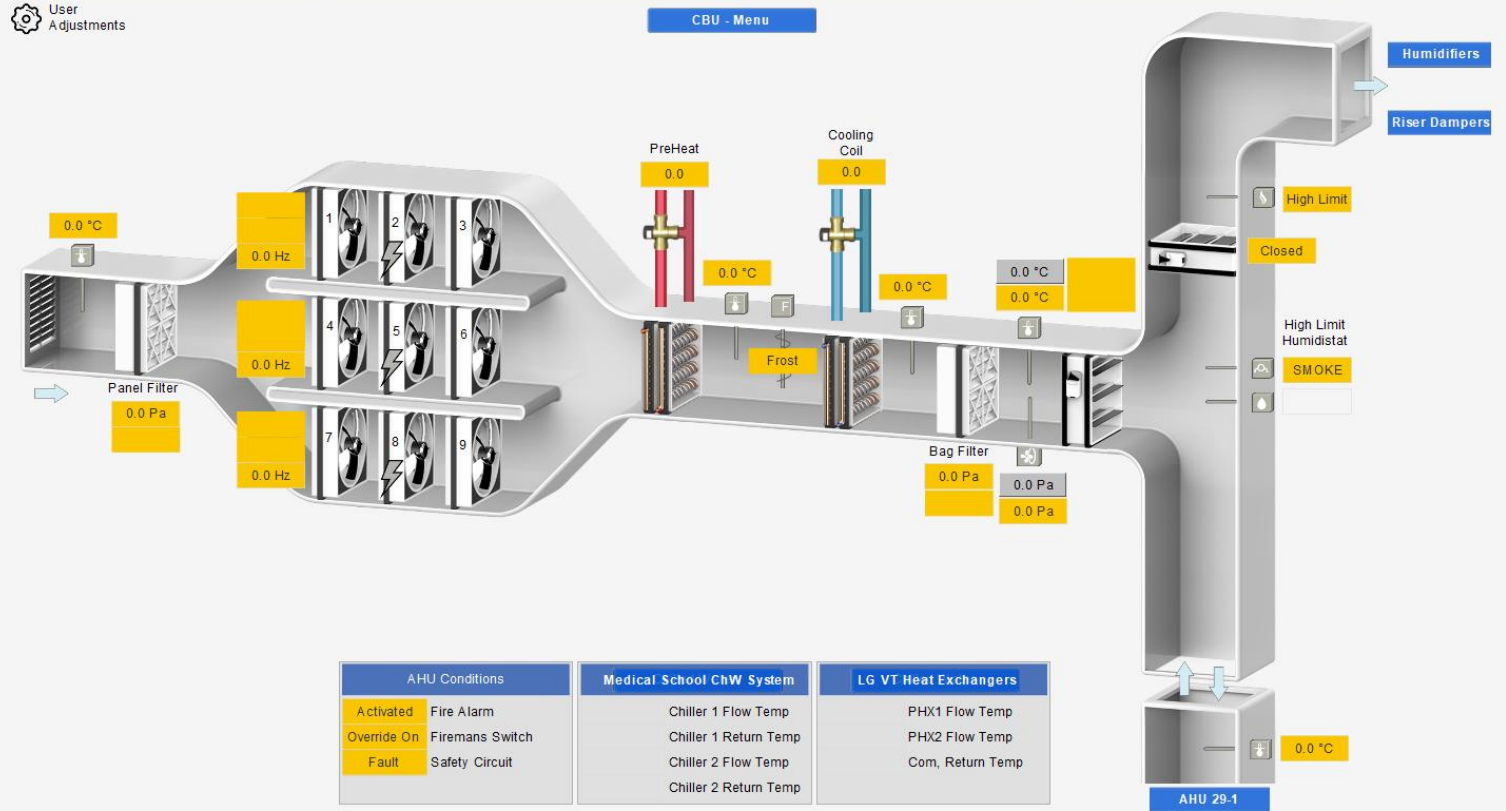

AHU Conditions	
Activated	Fire Alarm
Override On	Firemans Switch
Fault	Safety Circuit

Medical School ChW System	
	Chiller 1 Flow Temp
	Chiller 1 Return Temp
	Chiller 2 Flow Temp
	Chiller 2 Return Temp

LG VT Heat Exchangers	
	PHX1 Flow Temp
	PHX2 Flow Temp
	Com, Return Temp



G-North Plantroom, AHU 51 West Tower

Maintenance Alarms: 0
Fault Alarms: 0
Critical Alarms: 0

30-Apr-26 2:27 PM BST
User: admin
0.0 °C 0.0 %RH

- Daily Checks
- AHUs
- Buildings
- Chilled Water Systems
- Cold Water Services
- Dashboards
- Departments
- Duct Temps
- Domestic Hot Water Services
- Electrical
- Floors
- Gas
- Generators
- Heating Systems
- Metering
- Monitoring
- Outside Air Control
- Plantrooms
- Ventilation
- Historics

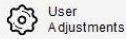

G-North Plantroom

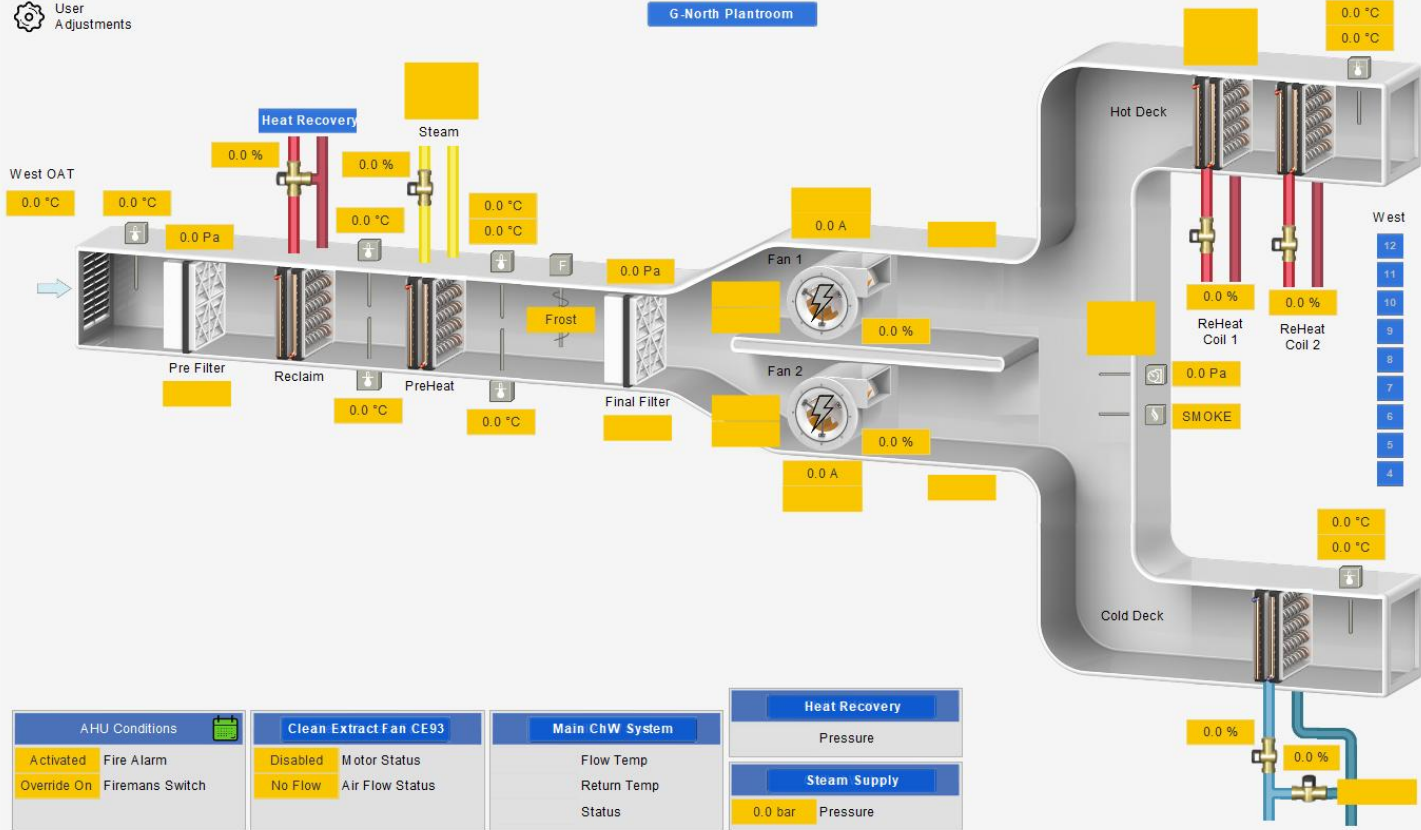

Floor 3 - Theatres
AHU 71-3 - Theatre 3 & H-West Extract CE81

Maintenance Alarms: 0
Fault Alarms: 0
Critical Alarms: 0

30-Apr-26 2:27 PM BST
User: admin
0.0 °C 0.0 %RH

- Daily Checks
- AHUs
- Buildings
- Chilled Water Systems
- Cold Water Services
- Dashboards
- Departments
- Duct Temps
- Domestic Hot Water Services
- Electrical
- Floors
- Gas
- Generators
- Heating Systems
- Metering
- Monitoring
- Outside Air Control
- Plantrooms
- Ventilation
- Historics

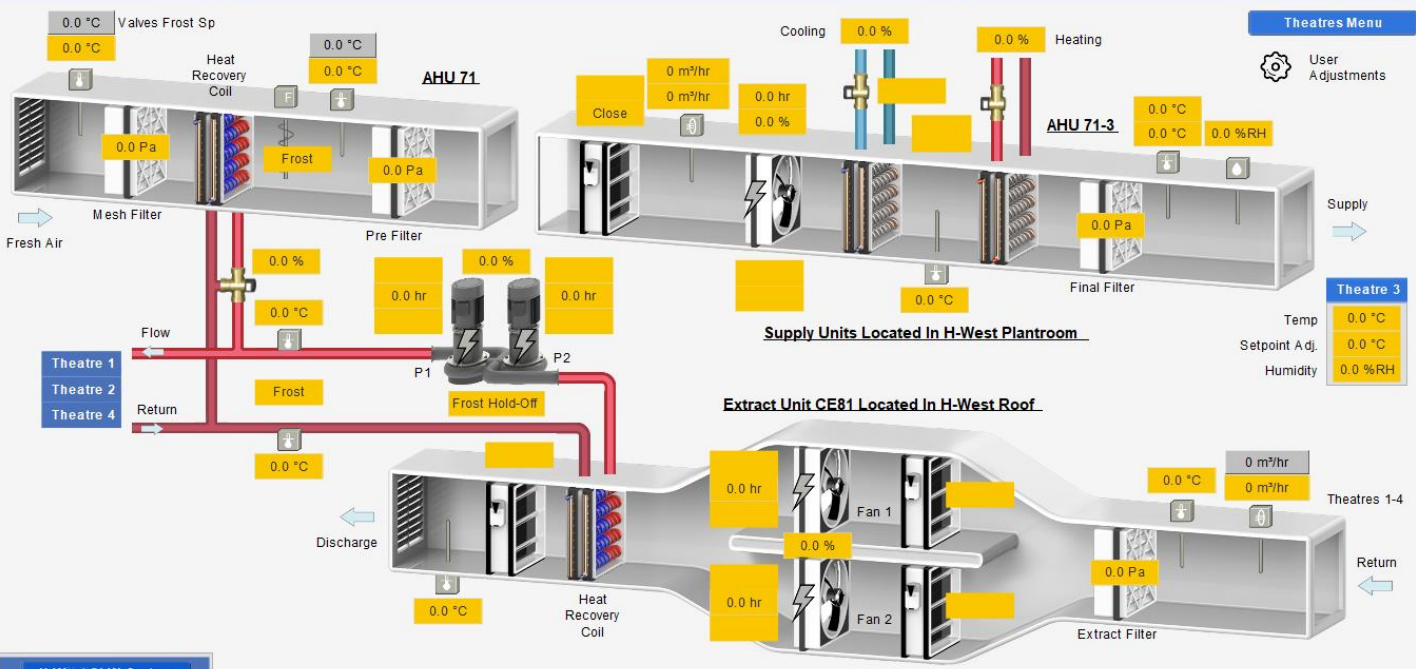

H-West ChW System	
0.0 °C	Flow Temp
0.0 °C	Return Temp

H-West Heating System	
0.0 °C	Flow Temp
0.0 °C	Return Temp

MCC Control Panel	
Alarm	UPS
Off	Generator

Safety Interlocks	
Activated	AHU Fire Alarm
Activated	AHU Emerg. Stop
Ok	AHU Safety I/locks
Activated	Extract Fire Alarm

AHU Plant Conditions	
Off	Dehum Mode
Off	Free Cooling Mode
No	Free Clg Available
No	Free Htg Available

Operating Theatre	
Off	Setback
Off	Normal
UnOcc.	Theatre PIR
UnOcc.	Prep PIR

Surgeons Panel	
Off	Ventilation
0.0 hr	Hours On
Active	Surgeons Switch
Off	Plant Extended

Theatres Menu

User Adjustments

Theatre 3

Temp 0.0 °C
Setpoint Adj. 0.0 °C
Humidity 0.0 %RH

Refresh Home Lock Info

Floor 4 ICU South - AHU 49-G South Reheater Coils

Maintenance Alarms: 0
Fault Alarms: 0
Critical Alarms: 0

30-Apr-26 2:44 PM BST
User: admin
0.0 °C 0 %RH

- Daily Checks
- AHUs
- Buildings
- Chilled Water Systems
- Cold Water Services
- Dashboards
- Departments
- Duct Temps
- Domestic Hot Water Services
- Electrical
- Floors
- Gas
- Generators
- Heating Systems
- Metering
- Monitoring
- Outside Air Control
- Plantrooms
- Ventilation
- Historics

AHU 49-G South

- ICU Menu
- South Floor Plan 1
- South Floor Plan 2
- South Chiller
- ICU PHEX
- Htr Batteries HB14-17

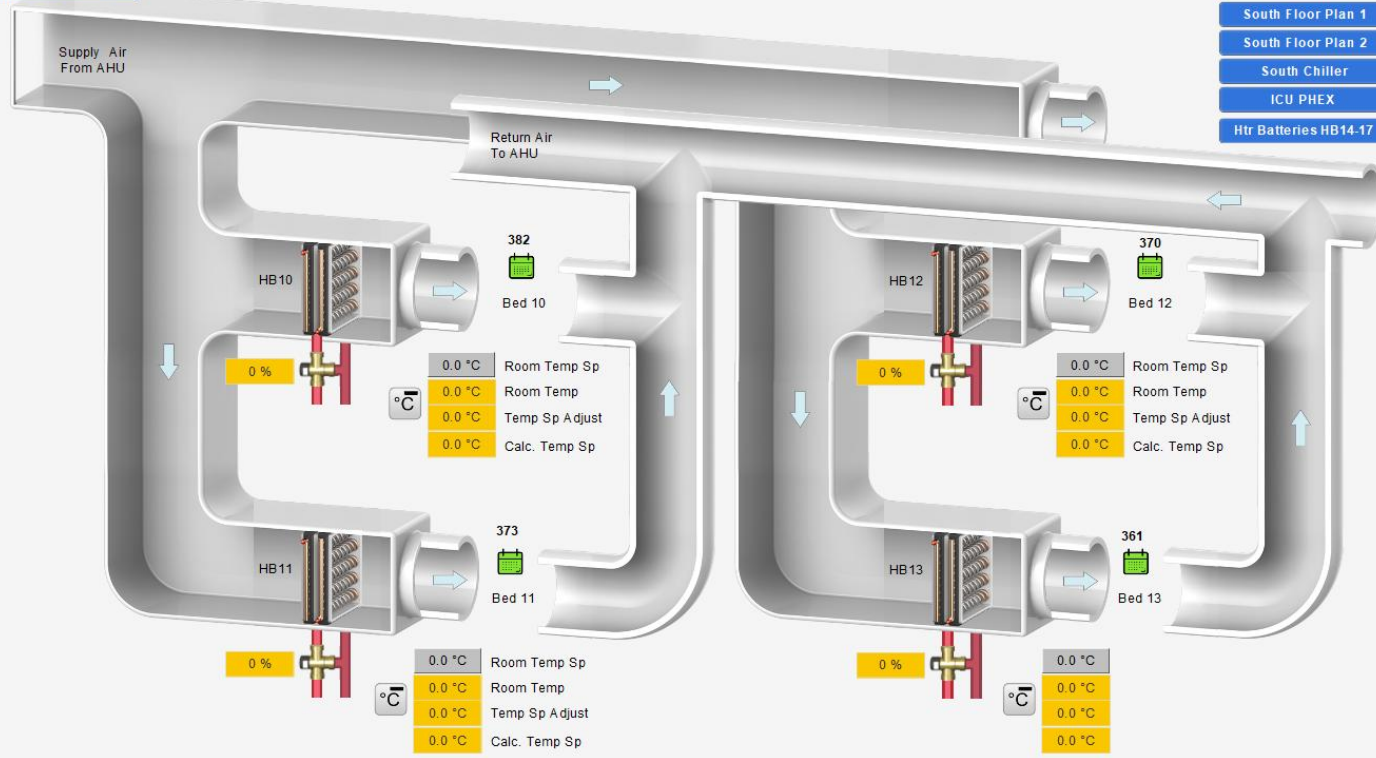

Refresh Home Lock Info

Energy Centre Steam Boilers

Maintenance Alarms : 0
Fault Alarms : 0
Critical Alarms : 0

30-Apr-26 2:36 PM BST
User: admin
0.0 °C 0 %RH

- Daily Checks
- AHUs
- Buildings
- Chilled Water Systems
- Cold Water Services
- Dashboards
- Departments
- Duct Temps
- Domestic Hot Water Service
- Electrical
- Floors
- Gases
- Generators
- Heating Systems
- Metering
- Monitoring
- Outside Air Control
- Plantrooms
- Ventilation
- Histories

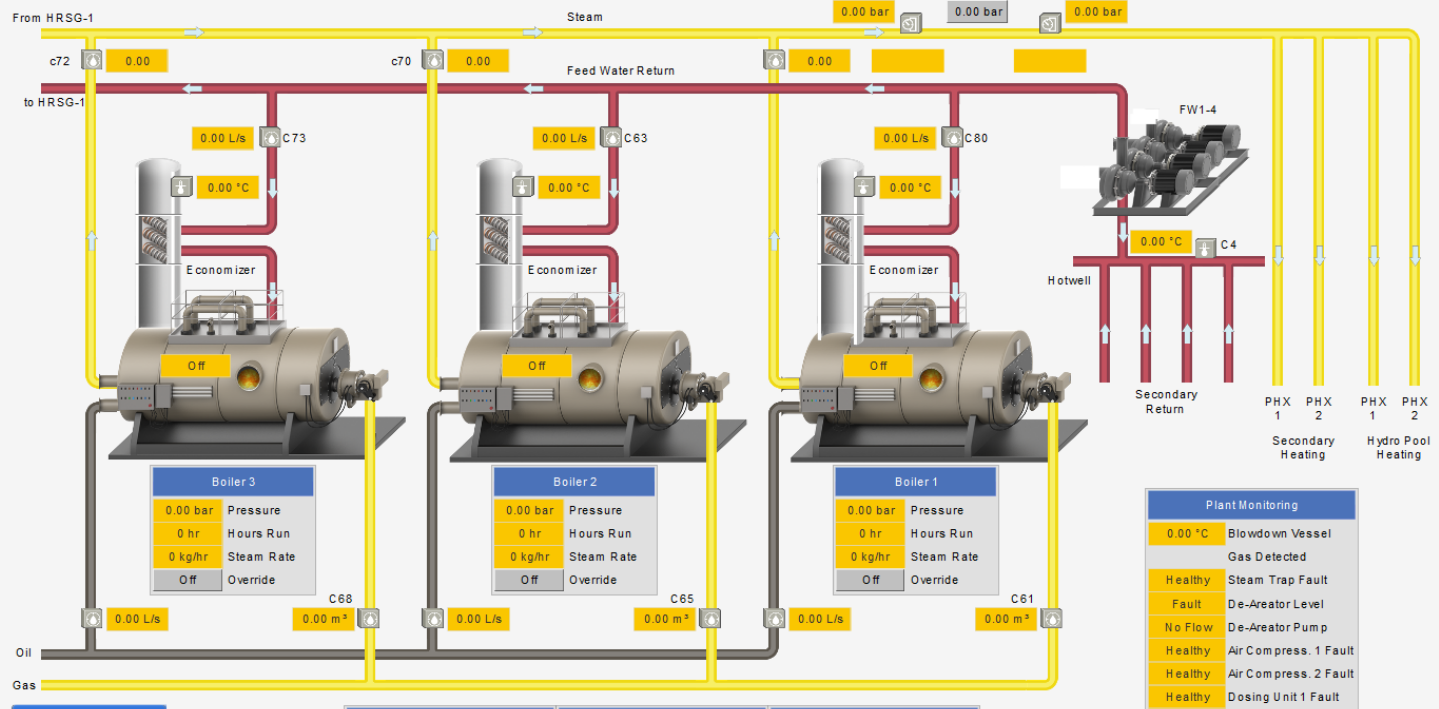

Heat Recovery System

Steam Boilers		Steam Boilers		Safety Interlocks	
Opened	Oil Valve Deadweight	0.00 bar	Banked Start Wint Sp	Activated	Fire Alarm
Rotate	Duty Change	0.00 bar	Banked Start Sum Sp	Activated	Common Emerg-Stop
0	Duty Boiler	0.00 °C	Banked Sp > OAT	Healthy	Gas Leak
0.00 bar	Run Setpoint			0.00 °C	OAT

Plant Monitoring	
0.00 °C	Blowdown Vessel
	Gas Detected
Healthy	Steam Trap Fault
Fault	De-Aerator Level
No Flow	De-Aerator Pump
Healthy	Air Compress. 1 Fault
Healthy	Air Compress. 2 Fault
Healthy	Dosing Unit 1 Fault
Healthy	Dosing Unit 2 Fault
Healthy	Dosing Unit 3 Fault
Healthy	Dosing Unit 4 Fault

Refresh Home Lock Info

Energy Centre Gas Turbine, Burner & Waste Heat Boiler

30-Apr-26 2:36 PM BST
User: admin
0.0 °C 0 %RH

- Daily Checks
- AHUs
- Buildings
- Chilled Water Systems
- Cold Water Services
- Dashboards
- Departments
- Duct Temps
- Domestic Hot Water Service
- Electrical
- Floors
- Gases
- Generators
- Heating Systems
- Metering
- Monitoring
- Outside Air Control
- Plantrooms
- Ventilation
- Histories

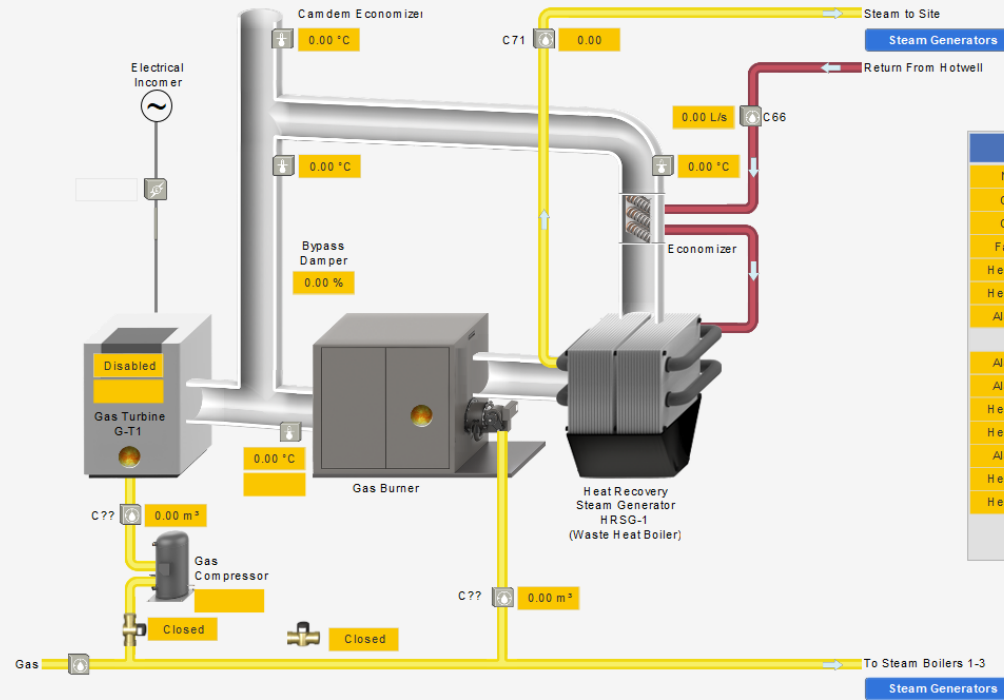

Waste Heat Boiler		Plant Monitoring	
No	Available	0.00 °C	Blowdown Vessel
Off	Operating		Gas Detected
Off	Status	Healthy	Steam Trap Fault
Fault	Pressure	Fault	De-Aerator Level
Healthy	Low Gas Pressure	No Flow	De-Aerator Pump
Healthy	High Gas Pressure	Healthy	Air Compress. 1 Fault
Alarm	Low Water	Healthy	Air Compress. 2 Fault
	Low Low Water	Healthy	Dosing Unit 1 Fault
Alarm	High Water	Healthy	Dosing Unit 2 Fault
Alarm	High High Water	Healthy	Dosing Unit 3 Fault
Healthy	Low Combustion Air	Healthy	Dosing Unit 4 Fault
Healthy	Low Pilot Air		
Alarm	Flame Failed		
Healthy	Gas Booster		
Healthy	Gas Detection		
Safety Interlocks			
Activated	Fire Alarm		
Activated	Common Emerg-Stop		
Healthy	Gas Leak		
0.00 °C	OAT		

- Daily Checks
 - AHUs
 - Buildings
 - Chilled Water Systems
 - Cold Water Services
 - Dashboards
 - Departments
 - Duct Temps
 - Domestic Hot Water Services
 - Electrical
 - Floors
 - Gases
 - Generators
 - Heating Systems
 - Metering
 - Monitoring
 - Outside Air Control
 - Plantrooms
 - Ventilation
 - Histories
- Biobank Plantroom Menu
 - Radioth./Linac AHU AC89
 - Biobank AHU AC90
 - Gene/Vct.Labs AHU AC91
 - Biobank Heating System
 - Biobank ChW System
 - Fume Cupboard Ext Fan

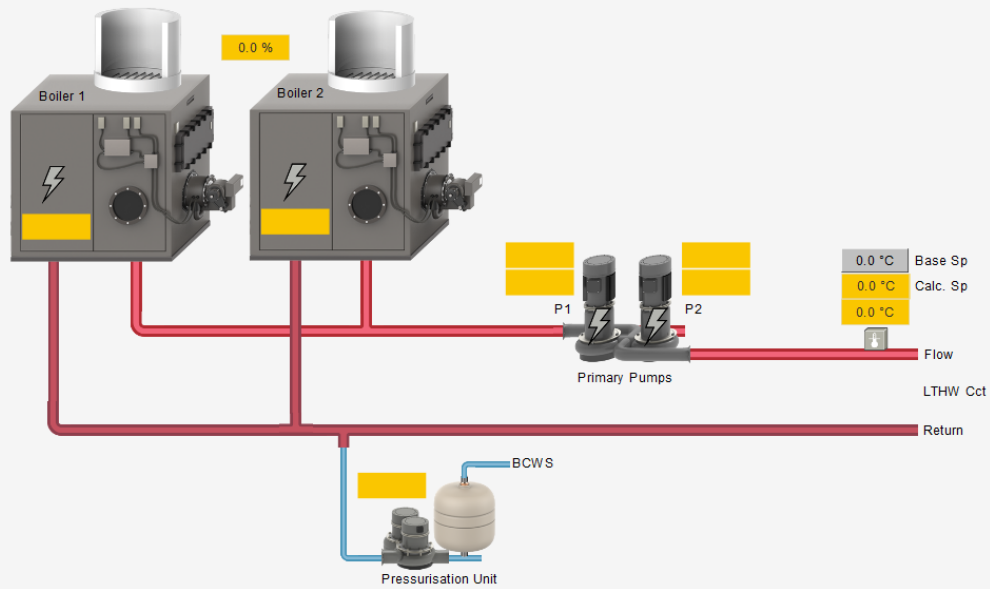

0.0 °C Base Sp
 0.0 °C Calc. Sp
 0.0 °C Flow
 LTHW Cct

Safety Interlocks		Boiler Adjustments		Pump Adjustments	
Activated	Fire Alarm	Off	Control	Pump 1	Pump Duty
Healthy	Emergency Stop	Boiler 1	Boiler Duty	Off	Inhibit Duty Change
Alarm	Safety Circuit	Off	Inhibit Duty Change	Reset	Flow Fail Reset
Fault	Trace Heating				

Floor G - Imaging & MRI
MRI 3, CT 1 - 3 LTHW System

Maintenance Alarms: 0
Fault Alarms: 0
Critical Alarms: 0

30-Apr-26 2:28 PM BST
User: admin
0.0 °C 0 %RH

- Daily Checks
- AHUs
- Buildings
- Chilled Water Systems
- Cold Water Services
- Dashboards
- Departments
- Duct Temps
- Domestic Hot Water Services
- Electrical
- Floors
- Gases
- Generators
- Heating Systems
- Metering
- Monitoring
- Outside Air Control
- Plantrooms
- Ventilation
- Histories

Imaging & MRI Menu

Space

0.0 °C

0 %RH

Fault

Space

0.0 °C

0 %RH

System Control

Off Control

Plate Heat Exchangers

Disable	Enable
Auto	Duty
Change	Duty Rotate
Reset	Fault Reset

LTHW Pumps

Disable	Enable
Auto	Duty
Change	Duty Rotate
Reset	Fault Reset

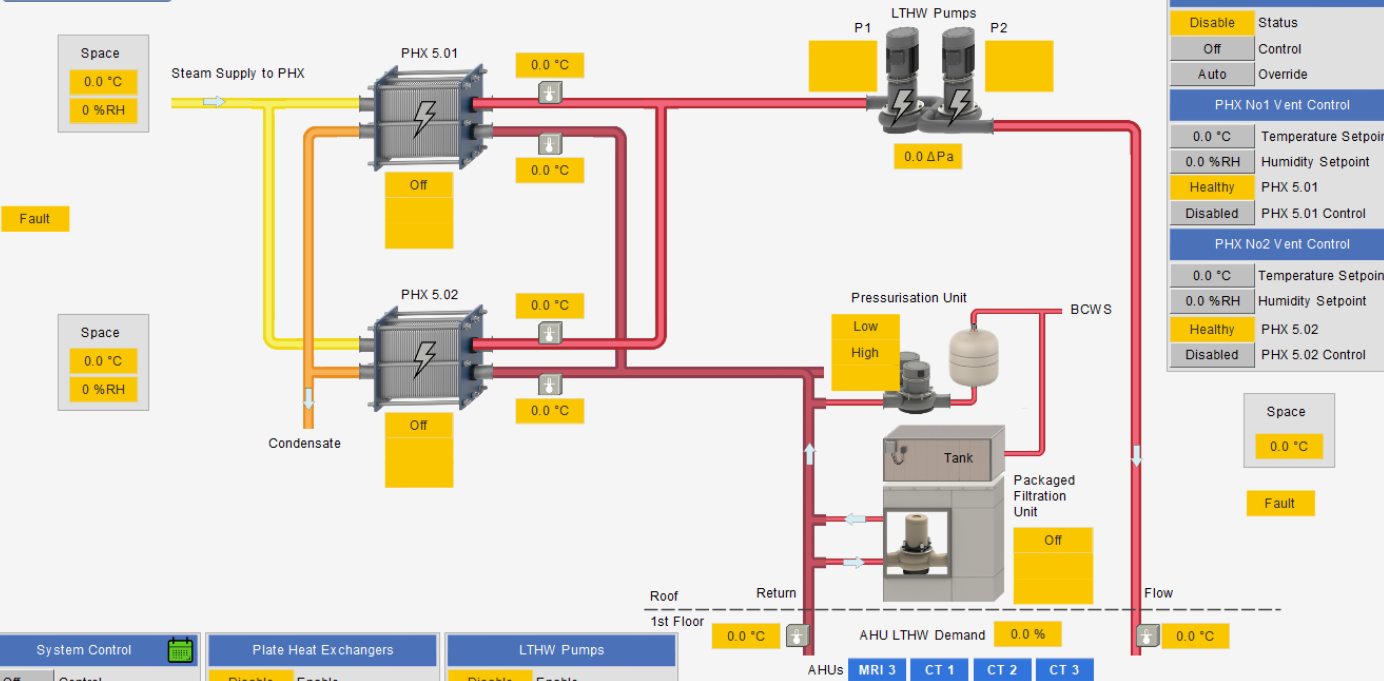

Plant Room Extract

Disable	Status
Off	Control
Auto	Override

PHX No1 Vent Control

0.0 °C	Temperature Setpoint
0.0 %RH	Humidity Setpoint
Healthy	PHX 5.01
Disabled	PHX 5.01 Control

PHX No2 Vent Control

0.0 °C	Temperature Setpoint
0.0 %RH	Humidity Setpoint
Healthy	PHX 5.02
Disabled	PHX 5.02 Control

Space

0.0 °C

Fault

Roof

1st Floor

Return

Flow

AHU LTHW Demand 0.0 %

AHUs MRI 3 CT 1 CT 2 CT 3

**Floor 4 H-West
OACS and Theatres Plate Heat Exchangers**

Maintenance Alarms: 0
Fault Alarms: 0
Critical Alarms: 0

30-Apr-26 2:28 PM BST
User: admin
0.0 °C 0 %RH

- Daily Checks
- AHUs
- Buildings
- Chilled Water Systems
- Cold Water Services
- Dashboards
- Departments
- Duct Temps
- Domestic Hot Water Services
- Electrical
- Floors
- Gases
- Generators
- Heating Systems
- Metering
- Monitoring
- Outside Air Control
- Plantrooms
- Ventilation
- Histories

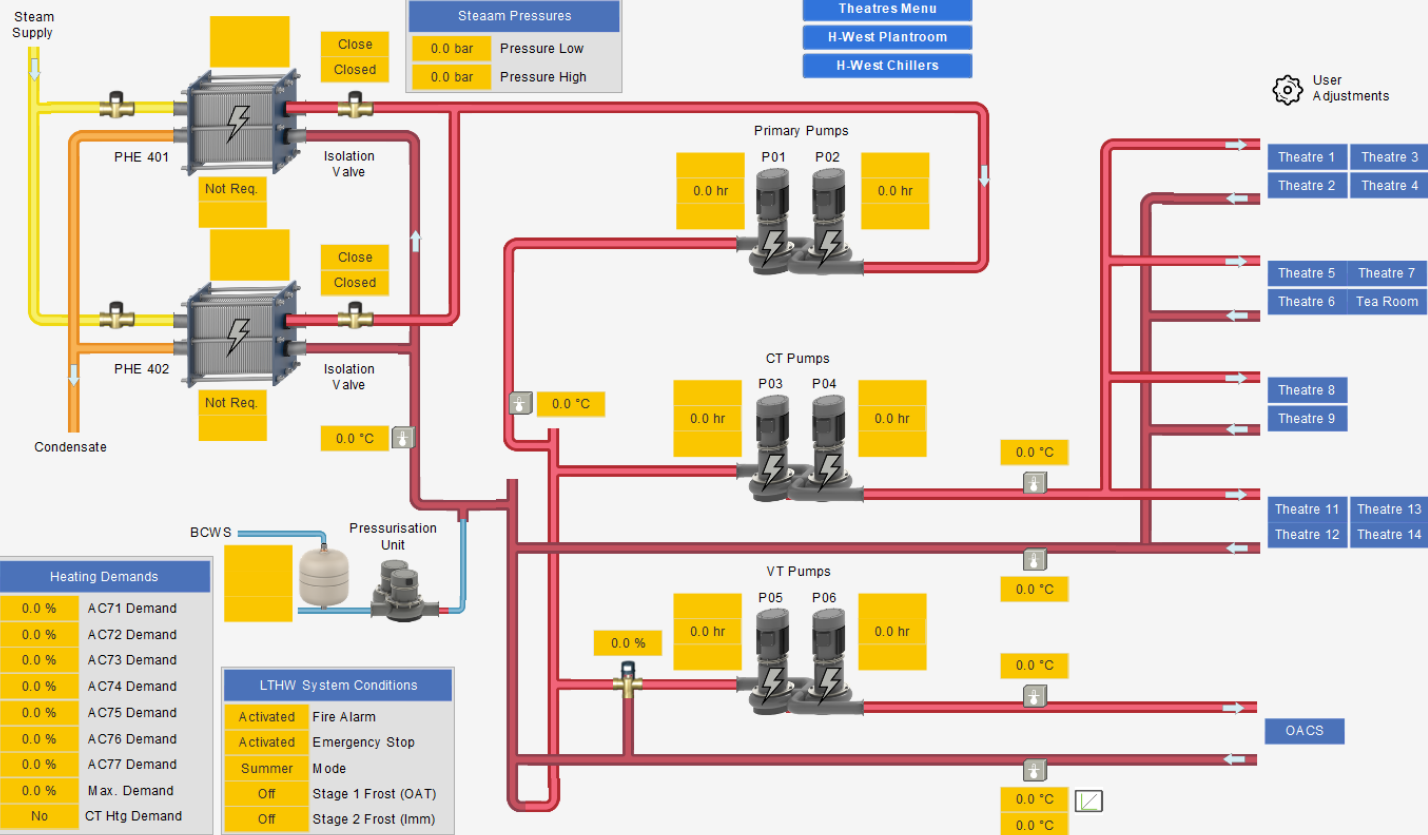

Heating Demands	
0.0 %	AC71 Demand
0.0 %	AC72 Demand
0.0 %	AC73 Demand
0.0 %	AC74 Demand
0.0 %	AC75 Demand
0.0 %	AC76 Demand
0.0 %	AC77 Demand
0.0 %	Max. Demand
No	CT Htg Demand

LTHW System Conditions	
Activated	Fire Alarm
Activated	Emergency Stop
Summer	Mode
Off	Stage 1 Frost (OAT)
Off	Stage 2 Frost (Imm)

Steam Pressures	
0.0 bar	Pressure Low
0.0 bar	Pressure High

- Theatres Menu
- H-West Plantroom
- H-West Chillers

User Adjustments

- Theatre 1 Theatre 3
- Theatre 2 Theatre 4
- Theatre 5 Theatre 7
- Theatre 6 Tea Room
- Theatre 8
- Theatre 9
- Theatre 11 Theatre 13
- Theatre 12 Theatre 14

OACS

Manufacturing Pharmacy Chilled Water System

Maintenance Alarms: 0
Fault Alarms: 0
Critical Alarms: 0

30-Apr-26 2:28 PM BST
User: admin
0.0 °C 0 %RH

- Daily Checks
- AHUs
- Buildings
- Chilled Water Systems
- Cold Water Services
- Dashboards
- Departments
- Duct Temps
- Domestic Hot Water Services
- Electrical
- Floors
- Gases
- Generators
- Heating Systems
- Metering
- Monitoring
- Outside Air Control
- Plantrooms
- Ventilation
- Histories

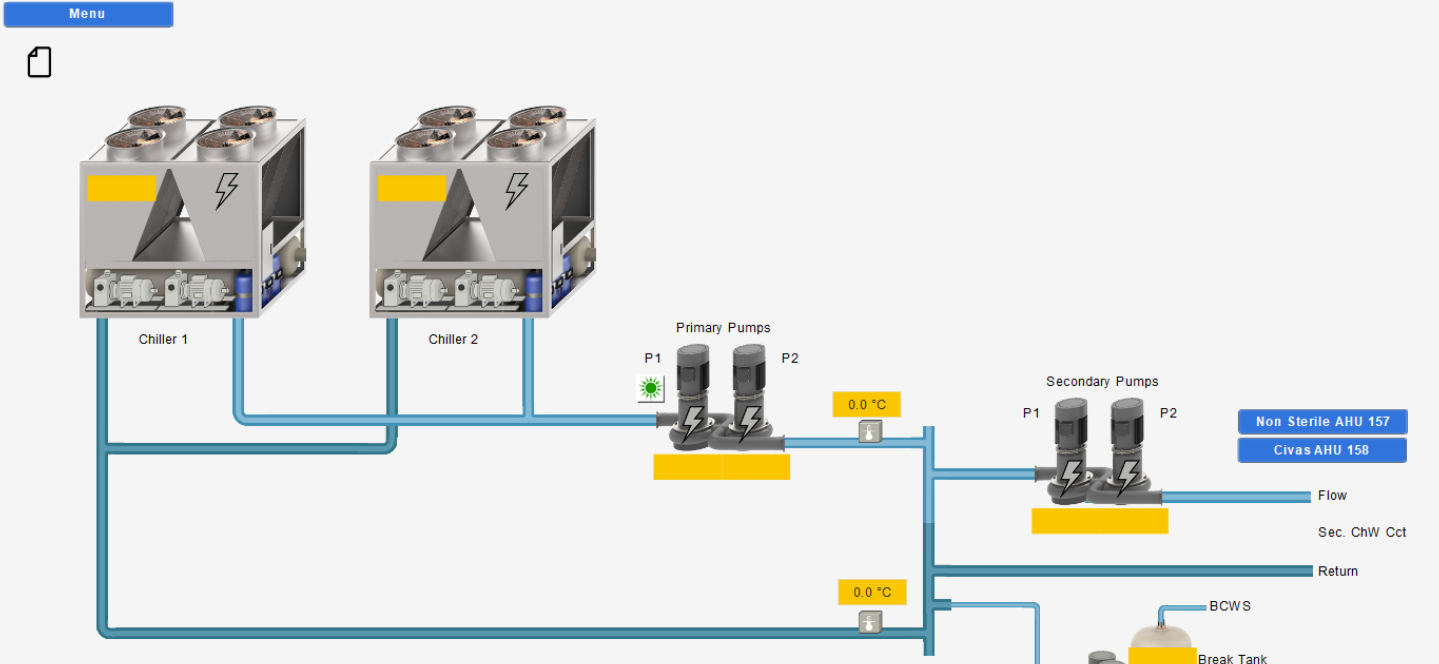

Plant Conditions		Chiller Adjustments		Primary Pumps Adjustments		Secondary Pumps Adjustments	
Activated	Fire Alarm	Off	Chiller Control		Duty Change		Duty Change
Off	System Control	0.0 %	Chiller Low Demand S	Pump 1	Duty	Pump 1	Duty
0.0 %	Cooling Demand Sp	0.0 %	Chiller High Demand S	Off	Inhibit Duty Change	Off	Inhibit Duty Change
0.0 °C	Pumps Frost Sp	0.0 %	Control Sp	Reset	Flow Fail Reset	Reset	Flow Fail Reset
InActive	Pumps Frost Active	0.0 min	Anti-Recycle Time	0.0 min	Run-On Time	0.0 min	Run-On Time

Refresh Home Lock Info

Floor G - Imaging & MRI
MRI 3, CT 1 - 3 ChW System

Maintenance Alarms: 0
Fault Alarms: 0
Critical Alarms: 0

30-Apr-26 2:29 PM BST
User: admin
0.0 °C 0 %RH

- Daily Checks
- AHUs
- Buildings
- Chilled Water Systems
- Cold Water Services
- Dashboards
- Departments
- Duct Temps
- Domestic Hot Water Services
- Electrical
- Floors
- Gas
- Generators
- Heating Systems
- Metering
- Monitoring
- Outside Air Control
- Plantrooms
- Ventilation
- Historics

Imaging & MRI Menu

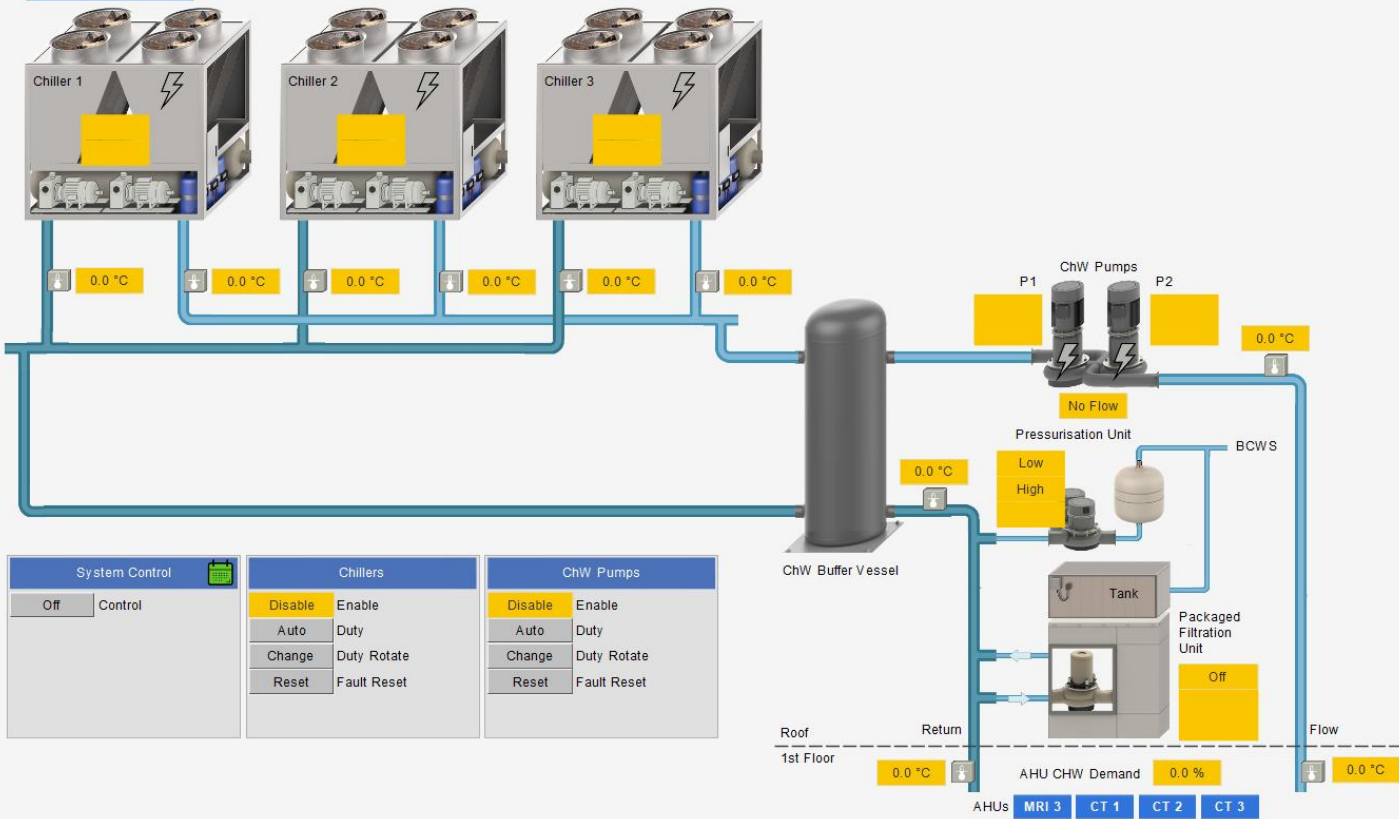

System Control		Chillers		ChW Pumps	
Off	Control	Disable	Enable	Disable	Enable
		Auto	Duty	Auto	Duty
		Change	Duty Rotate	Change	Duty Rotate
		Reset	Fault Reset	Reset	Fault Reset

Refresh Home Lock Info

Floor 4 H-West Chilled Water System

Maintenance Alarms: 0
Fault Alarms: 0
Critical Alarms: 0

30-Apr-26 2:29 PM BST
User: admin
0.0 °C 0 %RH

- Daily Checks
- AHUs
- Buildings
- Chilled Water Systems
- Cold Water Services
- Dashboards
- Departments
- Duct Temps
- Domestic Hot Water Services
- Electrical
- Floors
- Generators
- Heating Systems
- Metering
- Mechanical
- Refrigerant Air Control
- Plantrooms
- Ventilation
- Histories

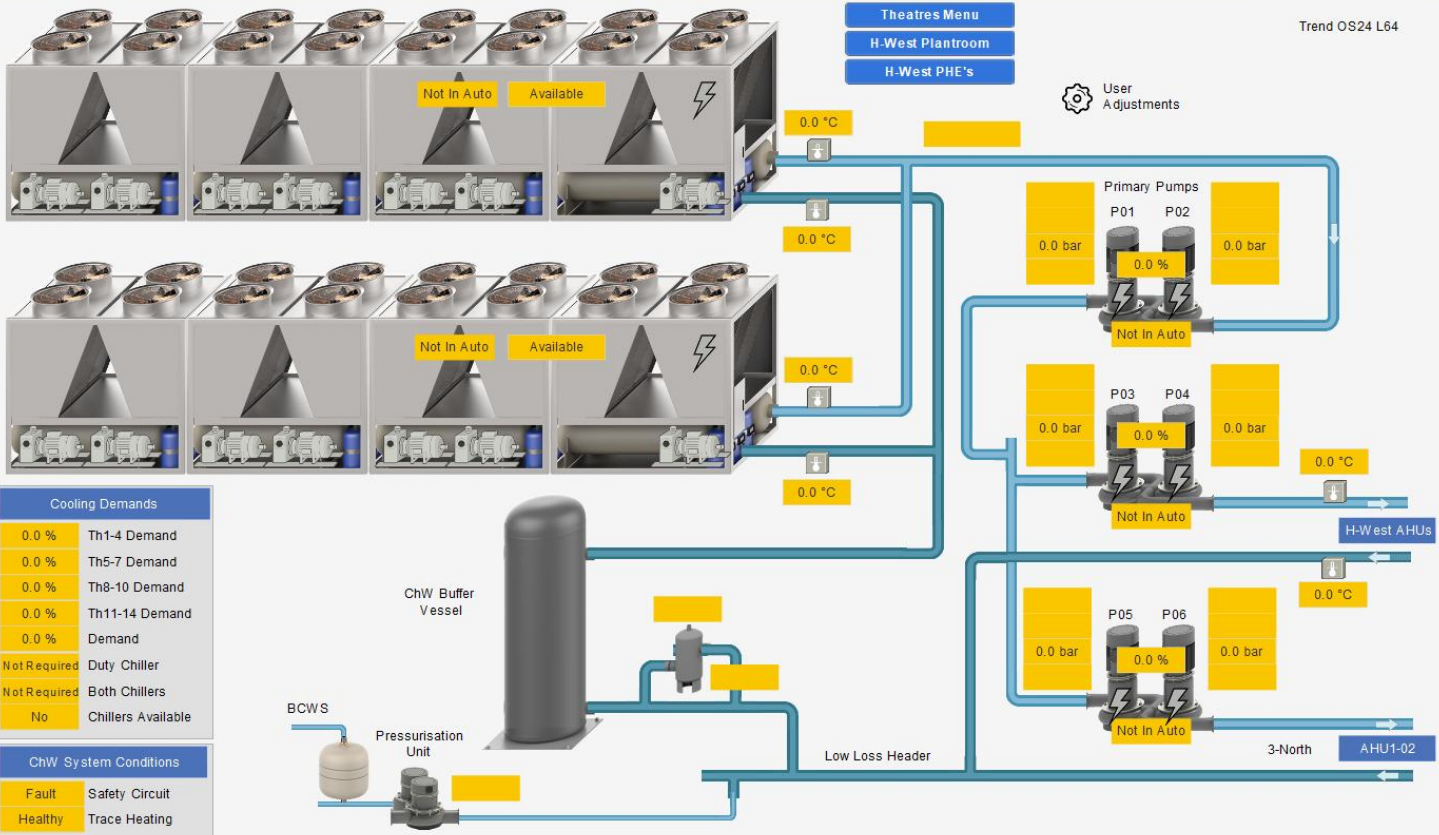

Cooling Demands	
0.0 %	Th1-4 Demand
0.0 %	Th5-7 Demand
0.0 %	Th8-10 Demand
0.0 %	Th11-14 Demand
0.0 %	Demand
Not Required	Duty Chiller
Not Required	Both Chillers
No	Chillers Available

ChW System Conditions	
Fault	Safety Circuit
Healthy	Trace Heating

- Theatres Menu
- H-West Plantroom
- H-West PHE's

User Adjustments

Trend OS24 L64

- Menu
- Heating System
- DHWS
- Chillers
- Cold Water Services
- Basement AHU
- AHU Reheat Valves
- Heating Zones
- Extract Fans
- Metering
- Miscellaneous
- TR Clinic
- Floor Plan
- AHU

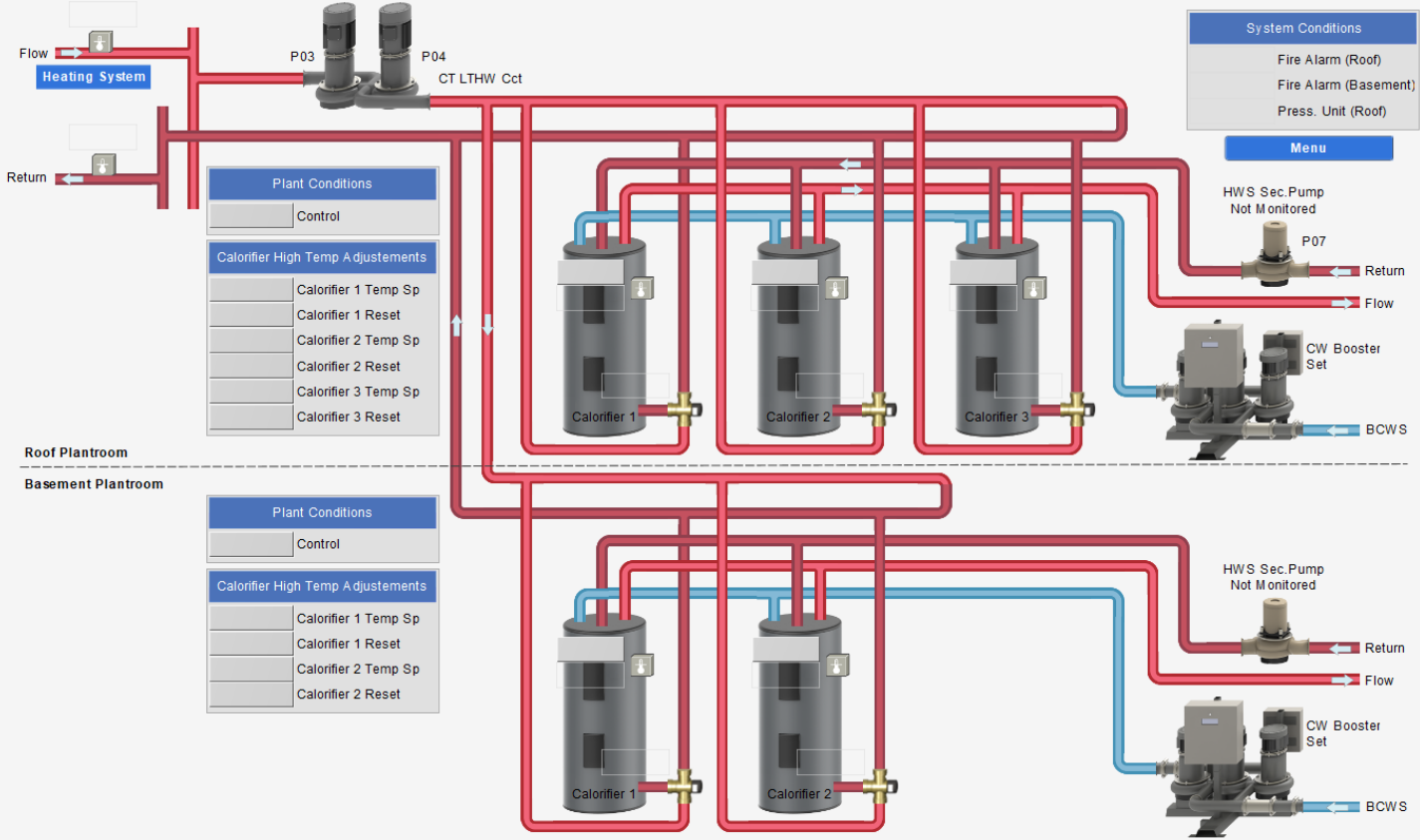



Floor 4 ICU West Floor Plan

Maintenance Alarms: 0
Fault Alarms: 0
Critical Alarms: 0

30-Apr-26 2:32 PM BST
User: admin
0.0 °C 0 %RH

- Daily Checks Flr
- AHUs Q
- Buildings 72
- Chilled Water Systems 11
- Cold Water Services 10
- Dashboards 9
- Departments 8
- Duct Temps 7
- Domestic Hot Water Services 6
- Electrical 5
- Floors 4
- Gases 3-B
- Generators 3-U
- Heating Systems 3
- Metering 2
- Monitoring 1
- Outside Air Control G
- Plantrooms LG
- Ventilation SL
- Histories



Information	
0.0 °C	HWS Flow Temp
0.0 °C	HWS Return Temp
0.0 °C	CWS Flow Temp
No	AHU Required
Healthy	AC Unit

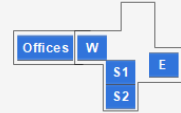

- ICU Menu
- West Offices
- Office Ventilation
- West Floor Plan
- AHU 79-H West
- West Chiller
- South Floor Plan 1
- South Floor Plan 2
- AHU 49-G South
- South Chiller
- East Floor Plan
- AHU 40-G East
- East Chiller
- OACS PHEX
- ICU PHEX

Floor 4 - ICU West

Room 4/413, Staff Base

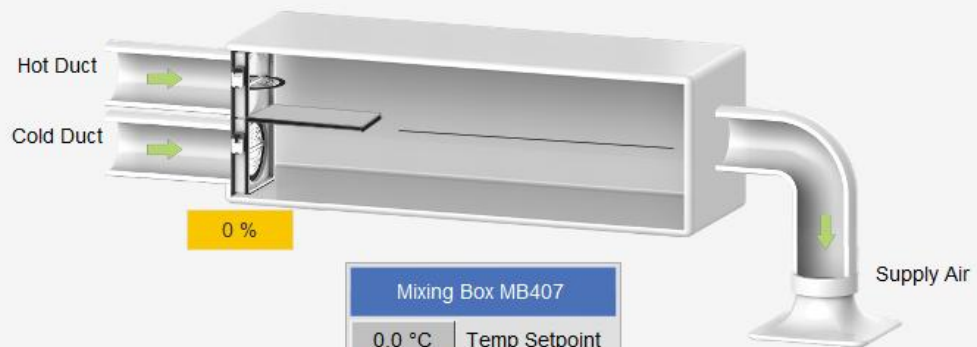

Mixing Box MB407	
0.0 °C	Temp Setpoint
0.0 °C	Setpoint Adjust
0.0 °C	Calc. Setpoint

°C 0.0 °C Room Temp

Refresh Home Lock Info

Lower Ground Floor
Sub Station D - Floor Plan

Maintenance Alarms: 0
Fault Alarms: 0
Critical Alarms: 0

30-Apr-26 2:38 PM BST
User: admin
0.0 °C 0 %RH

- Daily Checks
- AHUs
- Buildings
- Chilled Water Systems
- Cold Water Services
- Dashboards
- Departments
- Duct Temps
- Domestic Hot Water Services
- Electrical
- Floors
- Gases
- Generators
- Heating Systems
- Metering
- Monitoring
- Outside Air Control
- Plantrooms
- Ventilation
- Histories

TX17 Temperature Control	
Cooling Fin Temperature	0.00 °C
Fin Temp Low Alarm Sp	0.00 °C
Fin Temp High Alarm Sp	0.00 °C
Fin Temp Low Alarm Delay	0.00
Fin Temp High Alarm Delay	0.00
Fin Temp Low Alarm Enable	Off
Fin Temp High Alarm Enable	Off
Fin Temp Alarm	Healthy

TX18 Temperature Control	
Cooling Fin Temperature	0.00 °C
Fin Temp Low Alarm Sp	0.00 °C
Fin Temp High Alarm Sp	0.00 °C
Fin Temp Low Alarm Delay	0.00
Fin Temp High Alarm Delay	0.00
Fin Temp Low Alarm Enable	Off
Fin Temp High Alarm Enable	Off
Fin Temp Alarm	Healthy

Generator Switchboard	
MCB Incomer Supply	Off
MCB Incomer Trip	Healthy

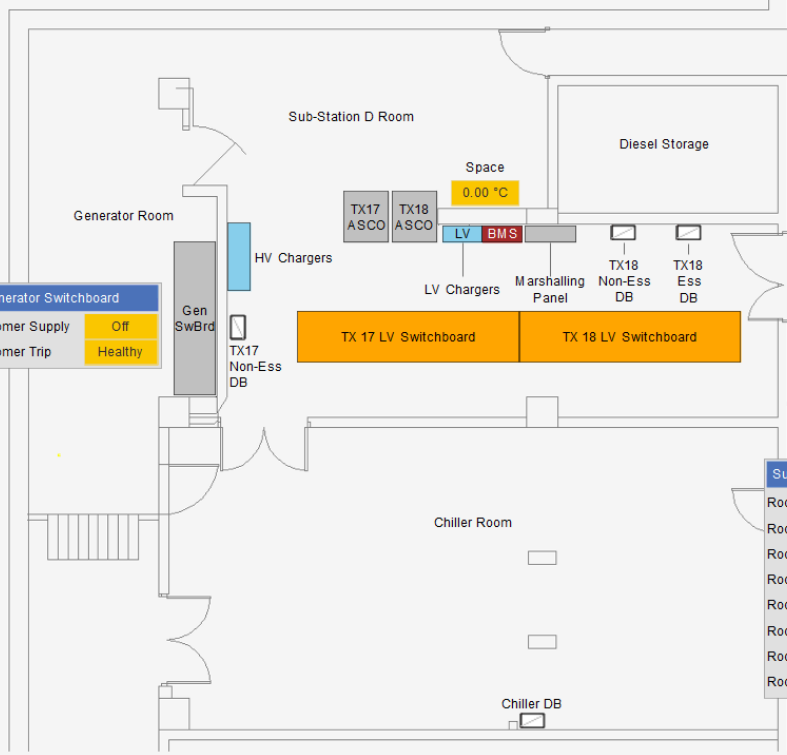
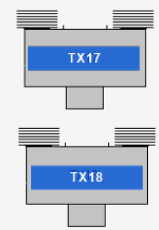

30V HV Battery Charging Units	
LV Charger 1 Status	Healthy
LV Charger 2 Status	Healthy
HV Charger 1 Status	Healthy
HV Charger 2 Status	Healthy

Sub-Station D Room Temperature Control	
Room Temperature	0.00 °C
Room Temp Low Alarm Sp	0.00 °C
Room Temp High Alarm Sp	0.00 °C
Room Temp Low Alarm Delay	0.00
Room Temp High Alarm Delay	0.00
Room Temp Low Alarm Enable	Off
Room Temp High Alarm Enable	Off
Room Temp Alarm	Healthy

Refresh Home Lock Info

Lower Ground Floor Sub Station D - TX17 LV Switchboard

Maintenance Alarms: 0
Fault Alarms: 0
Critical Alarms: 0

30-Apr-26 2:38 PM BST
User: admin

0.0 °C 0 %RH

- Daily Checks
- AHUs
- Buildings
- Chilled Water Systems
- Cold Water Services
- Dashboards
- Departments
- Duct Temps
- Domestic Hot Water Services
- Electrical
- Floors
- Gases
- Generators
- Heating Systems
- Metering
- Monitoring
- Outside Air Control
- Plantrooms
- Ventilation
- Histories

Floor Plan

TX17 LV Switchboard	TX18 LV Switchboard	TX17 ASCO	TX18 ASCO
TX17 Non-Ess Dist. Board	TX18 Non-Ess Dist. Board	TX18 Ess Dist. Board	Chiller Dist. Board

Key

■ On	■ Off	■ Tripped
---	---	--

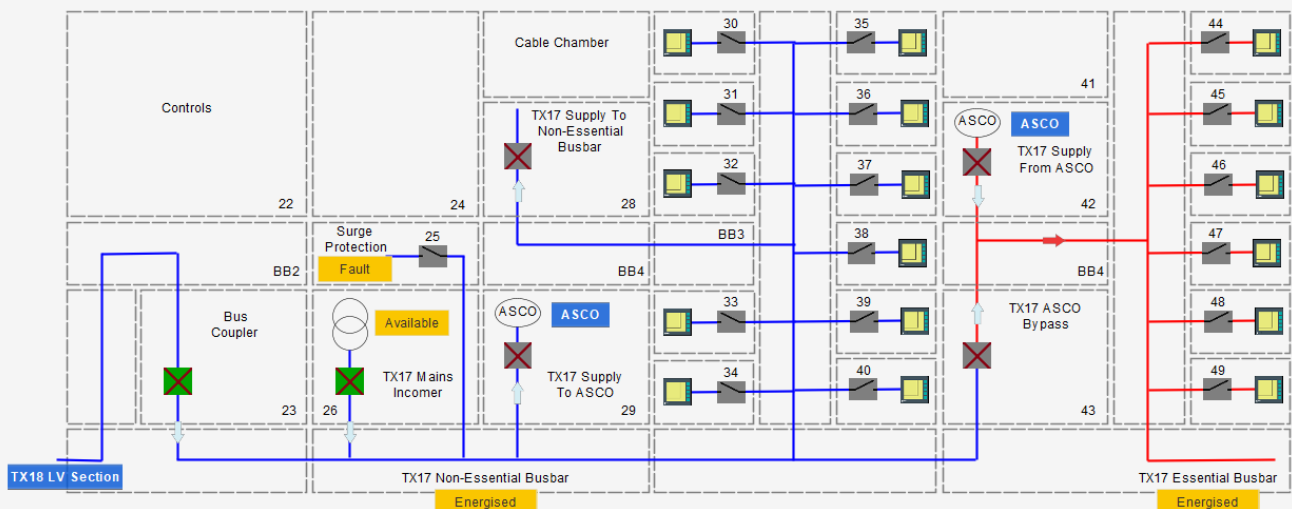

TX17			
HV EPO Operated	Healthy	TX RMU Low gas	Healthy
HV Inverter Trip Received	Healthy	TX RMU MCB Supply	Off
LV EPO Operated	Healthy	Overtemp Alarm	Healthy
LV 24v DC Supply	Healthy	Overtemp Trip	Healthy
		Restricted Earth Fault	Healthy

Mains Monitoring	
Mains Incoming Supply PFR(A)	Fault
Mains Incoming Supply PFR(B)	Fault
Supply from ASCO PFR(A)	On
Supply from ASCO PFR(B)	On

Generator Switchboard	
MCB Incomer Supply	Off
MCB Incomer Trip	Healthy

HV/LV DC Battery Charging Units	
LV Charger 1 Status	Healthy
LV Charger 2 Status	Healthy
HV Charger 1 Status	Healthy
HV Charger 2 Status	Healthy

G-East TX12 LV Switchboard - Monitoring

Maintenance Alarms: 0
 Fault Alarms: 0
 Critical Alarms: 0

30-Apr-26 2:39 PM BST
 User: admin
 0.0 °C 0 %RH

- Daily Checks
- AHUs
- Buildings
- Chilled Water Systems
- Cold Water Services
- Dashboards
- Departments
- Duct Temps
- Domestic Hot Water Services
- Electrical
- Floors
- Gases
- Generators
- Heating Systems
- Metering
- Monitoring
- Outside Air Control
- Plantrooms
- Ventilation
- Histories

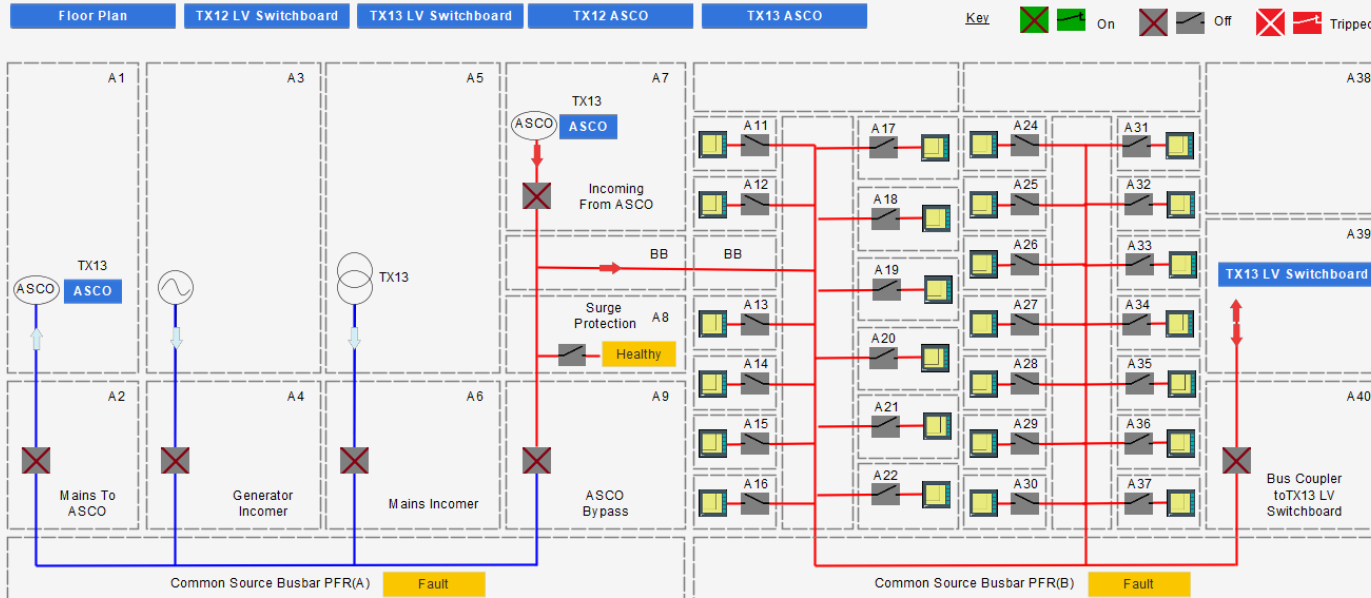

TX13			
Inverter Trip Received	Fault	System in Parallel	Healthy
Overtemp Alarm	Fault	Mains Failed	Healthy
Key Switch Position	Auto	Mains Supply ACB Trip	Healthy
24v DC Control Supply	Fault	Gen. Upstream Inter. Trip	Healthy
Mains Shunt Trip Fault	Healthy	LV EPO Operated	Healthy
Common Alarm	Healthy	Restricted Earth Fault	Healthy

Mains Monitoring	
Mains Incoming Supply PFR(A)	Fault
Mains Incoming Supply PFR(B)	Fault
Supply from ASCO PFR(A)	On
Supply from ASCO PFR(B)	On

Generator Monitoring	
Gen. Incoming Supply PFR(A)	Off
Gen. Incoming Supply PFR(B)	Off
Gen to ASCO Iso. MCCB Status	Off
Gen to ASCO Iso. MCCB Trip	Healthy
Gen. to ASCO MCCB PFR(A)	Off
Gen. to ASCO MCCB PFR(B)	Off

LV DC Battery Charging Units	
Charger 1 Battery Fault	Fault
Charger 2 Battery Fault	Fault

Key: ■ On ■ Off ■ Tripped

Critical Plant Dashboard

Critical Alarms

30-Apr-26 2:41 PM BST
User: admin
0.0 °C 0 %RH

Cold Water Services

Mains Water Break Tank

Mains Inlet Pressure 0.00 bar

Break Tank Discharge Press 0.00 bar

Break Tank 1 Level 0%

Break Tank 2 Level 0%

VIE - Oxygen Monitoring

Loading Bay - Flow Rate 0.0 m³/hr

Loading Bay - Velocity 0.0 m/s

Rowland Hill - Flow Rate 0.0 m³/hr

Rowland Hill - Velocity 0.0 m/s

Generators

Generator 1 - Mains online

Generator 1 - Run

Generator 2 - Mains online

Generator 2 - Run

Generator 3 - Mains online

Generator 3 - Run

To contact MITIE call switchboard:
INTERNALLY - dial 0 and call
EXTERNALLY - Call 02077941615
Switchboard will bleep Mitie on call
engineer at your request

Energy Centre - Steam Plant

Fire Alarm Status

Emergency Shut Off

Gas Leak Detected

Gas Turbine Fault

CHP Operation Stopped

CHP Flue Temperature 0.0 °C

CHP High Level Space 0.0 °C

Steam Header Pressure 1 0.00 bar

Steam Header Pressure 2 0.00 bar

Steam Header Pressure 1 Low

Steam Header Pressure 2 Low

G South Steam Pressure 0.0 bar

Energy Centre - CHW

CHW Common Flow 0.0 °C

CHW Common Return 0.0 °C

Absorption Chiller 1 Status

Absorption Chiller 1 Running

Absorption Chiller 2 Status

Absorption Chiller 2 Running

Electric Chiller Status

Electric Chiller Running

UCL Cardiac MRI Process Chillers

Cardiac MRI CHW Flow 0.0 °C

Cardiac MRI CHW Return 0.0 °C

Chiller 1 Status

Chiller 1 Pump

Chiller 2 Status

Chiller 2 Pump

HWS Services

Podium DHWS PHX

Podium HWS PHX1 Flow 0.0 °C

Podium HWS PHX2 Flow 0.0 °C

Podium HWS Return 0.0 °C

Tower DHWS PHX

Tower HWS PHX1 Flow 0.0 °C

Tower HWS PHX2 Flow 0.0 °C

Tower HWS Return 0.0 °C

Critical Ventilation

AHU 1 - A&E ATA	AHU 71/1 Theatre 1	AHU 98 - HLIU Room 1
AHU 29/1 - Med School	AHU 71/2 Theatre 2	AHU 99 - HLIU Room 2
AHU 29/2 - Med School	AHU 71/3 Theatre 3	AHU101 - Nuclear Med
AHU 39 - 2N ICU	AHU 71/4 Theatre 4	AHU102 - ITU/EPIC 3N
AHU 40 - ICU East	CE81 - Theatres 1-4	AHU105 - HSIDU 11W
AHU 41 - East Podium	AHU 72/1 Theatre 5	AHU106 - HSIDU 11W
AHU 46 - East Tower	AHU 72/2 Theatre 6	AHU147 - MRI 1
AHU 47 - South Tower	AHU 72/3 Theatre 7	AHU148 - MRI 2
AHU 49 - ICU South	CE82 - Theatres 5-7	AHU1.01 - MRI 3
AHU 51 - West Tower	AHU 73/1 Theatre 8	AHU149 - MRI 4
AHU 52 - North Podium	AHU 73/2 Theatre 9	AHU1.02 - CT 1
AHU 53 - North Tower	CE83 - Theatres 8-9	AHU1.03 - CT 2
AHU 55 - HDU	AHU 73B Theatre 10	AHU1.04 - CT 3
AHU 75 - West Podium	AHU 74/1 Theatre 11	AHU150 - IRCU Lab 4
AHU 76 - West Podium	AHU 74/2 Theatre 12	AHU151 - IRCU Lab 1 & 2
AHU 77 - North/West	AHU 74/3 Theatre 13	AHU152 - IRCU Lab 3 & 5
AHU 79 - ICU West	AHU 74/4 Theatre 14	AHU155 - Cardiac MRI
AHU 80 - Maternity	CE84 - Theatres 11-14	AHU110 - Ian Charlesden
AHU 89 - Radiotherapy	AHU114 - Theatre 15	AHU MV5 - Mortuary
AHU - Day Theatre	AHU115 - Theatre 16	AHU Grove TB
AHU113 - Endoscopy	AHU116 - Recovery	